

**KLT-VM01-GC0308 V1.2****0.3MP GalaxyCore GC0308 DVP Parallel Interface Fixed Focus Camera Module**

Front View

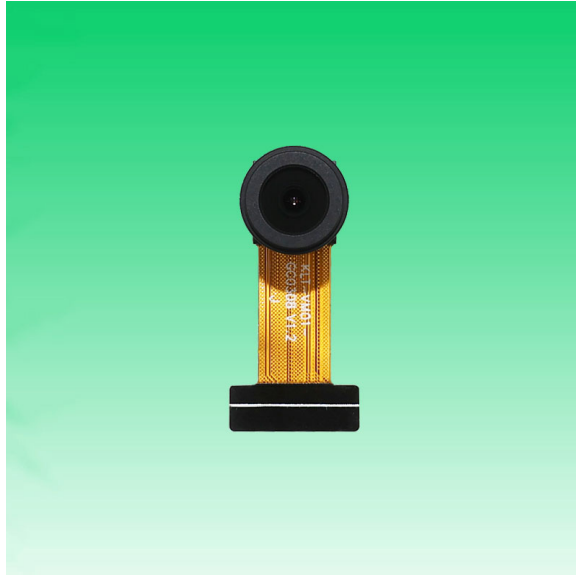
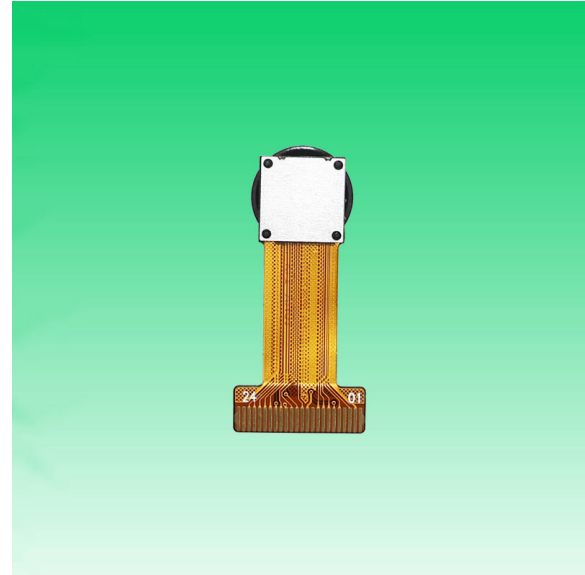

Back View

**Specifications**

<b>Camera Module No.</b>	<b>KLT-VM01-GC0308 V1.2</b>
<b>Resolution</b>	0.3MP
<b>Image Sensor</b>	GC0308
<b>Sensor Type</b>	1/6.5"
<b>Pixel Size</b>	3.4 um x 3.4 um
<b>EFL</b>	1.75 mm
<b>F.NO</b>	2.70
<b>Pixel</b>	640 x 480
<b>View Angle</b>	97.8°(DFOV) 75.6°(HFOV) 55.8°(VFOV)
<b>Lens Dimensions</b>	8.00 x 8.00 x 12.50 mm
<b>Module Size</b>	26.00 x 12.50 mm
<b>Module Type</b>	Fixed Focus
<b>Interface</b>	DVP Parallel
<b>Auto Focus VCM Driver IC</b>	None
<b>Lens Type</b>	650nm IR Cut
<b>Operating Temperature</b>	-30°C to +80°C
<b>Mating Connector</b>	FH12-24S-0.5SH



## KLT-VM01-GC0308 V1.2

### 0.3MP GalaxyCore GC0308 DVP Parallel Interface Fixed Focus Camera Module



Top View



Side View



Bottom View

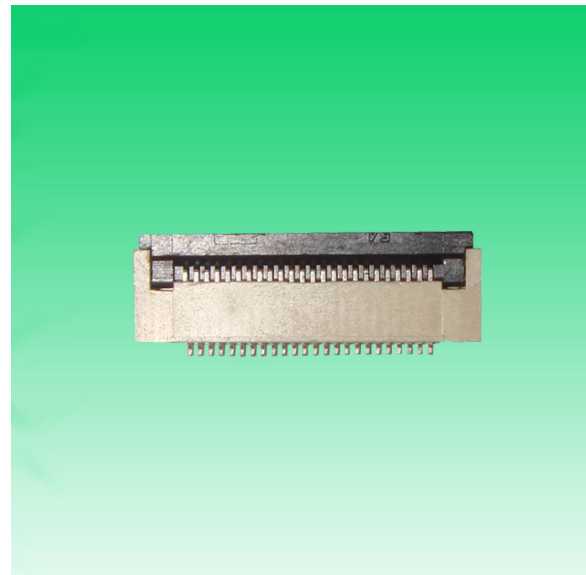

Mating Connector

RoHS	
PIN	SIGNAL
1	NC
2	DGND
3	SIO_D
4	NC
5	SIO_C
6	RESET
7	VSYNC
8	PWDN
9	HREF
10	NC
11	DVDD 2.8V
12	D7
13	XCLK
14	D6
15	DGND
16	D5
17	PCLK
18	D4
19	D0
20	D3
21	D1
22	D2
23	NC
24	NC

Version	Information	Date
V1.0	First Version	12-10-2020
V1.2	Change lens and holder	5-16-2023

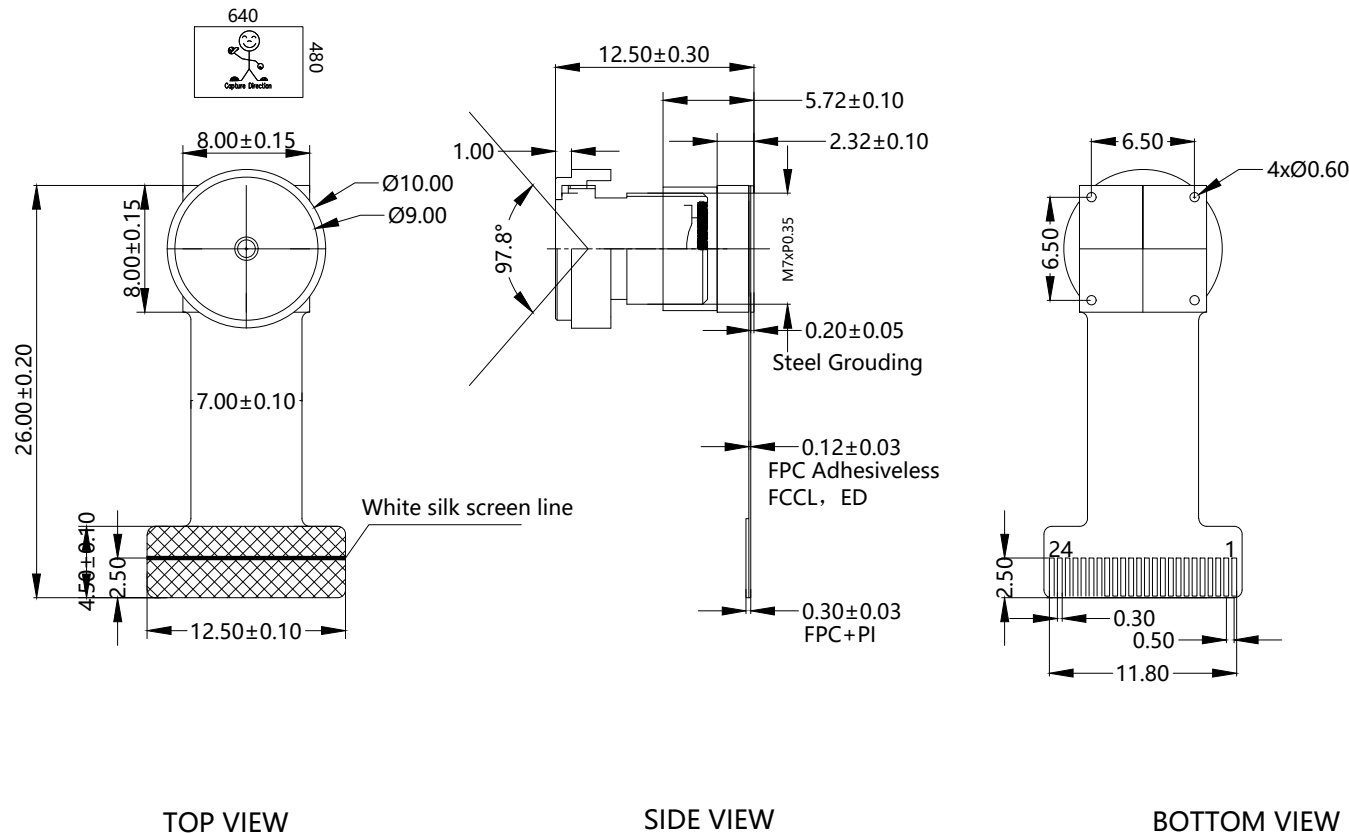

**Parameter:**

1、 Sensor specification:  
 Image Sensor: GC0308  
 Pixel: 3.4um\*3.4um  
 Lens Type: 1/6..5  
 Important Voltage Description:  
 DVDD2.8V (external power supply);

2、 Lens specification:  
 FOV: 97.8°(D);75.6°(H);55.8°(V);  
 F/NO.: 2.7  
 TV distortion: <-7.8%  
 Focal length: 1.75mm  
 Composition: 4E+IR FILTER  
 IR Cut Coating: 650nm±10nm@50%

<b>Kai Lap Technologies Group Ltd</b>					
Designed By	Kevin	Model Name:	KLT-VM01-GC0308 V1.2		
Checked By	Aouly_Yan	Projection Type:	Unit:	Material:	
		 Third Angle	mm	-----	
		Scale:	Sheet:	Version:	
		1:1	1 of 1	1/0	



**1/6.5” VGA CMOS Image Sensor  
GC0308**

**DataSheet**

**Only for FAE**

2010-01-28

**GalaxyCore Inc.**

## 1. Sensor Overview

### 1.1 General Description

The GC0308 features 640V x 480H resolution with 1/6.5-inch optical format, and 4-transistor pixel structure for high image quality and low noise variations. It delivers superior image quality by powerful on-chip design of a 10-bit ADC, and embedded image signal processor.

The full scale integration of high-performance and low-power functions makes the GC0308 best fit the design, reduce implementation process, and extend the battery life of cell phones, PDAs, and a wide variety of mobile applications.

The on-chip ISP provides a very smooth AE (Auto Exposure) and accurate AWB (Auto White Balance) control. It provides various data formats, such as Bayer RGB, RGB565, YCbCr 4:2:2. It has a commonly used two-wire serial interface for host to control the operation of the whole sensor.

The product is capable of operating at up to 30 frames per second at 24MHZ clock in VGA mode, with complete user control over image quality and data formatting.

### 1.2 Features

- ◆ Standard optical format of 1/6.5 inch
- ◆ Various output formats: YCbCr4:2:2, RGB565, Raw Bayer
- ◆ Single power supply requirement (2.8v)
- ◆ Windowing support
- ◆ Horizontal /Vertical mirror
- ◆ Image processing module
- ◆ Package: CSP

### 1.3 Application

- ◆ Cellular Phone Cameras
- ◆ Notebook and desktop PC cameras
- ◆ PDAs
- ◆ Toys
- ◆ Digital still cameras and camcorders
- ◆ Video telephony and conferencing equipments
- ◆ Security systems
- ◆ Industrial and environmental systems
- ◆ Bar code reader

### 1.4 Technical Specifications

Parameter	Typical value
Optical Format	1/6.5 inch
Pixel Size	3.4um x 3.4um
Active pixel array	648 x 488
ADC resolution	10 bit ADC
Max Frame rate	30fps@24Mhz,VGA
Power Supply	2.7 ~ 3.3V, typical 2.8V
Power Consumption	TBD
SNR	TBD
Dark Current	TBD
Sensitivity	TBD
Operating temperature:	-30~80°C
Stable Image temperature	-10~60°C
Optimal lens chief ray angle(CRA)	27°
Package type	CSP

# 0.5mm and 1mm Pitch Connectors For FPC/FFC

## FH12 Series

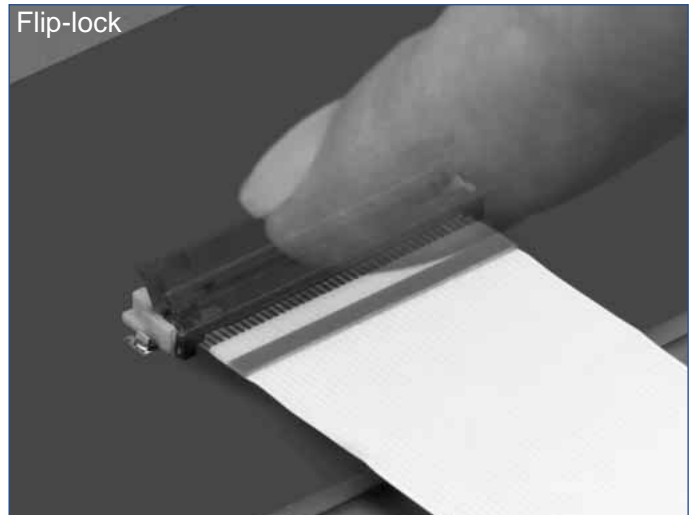
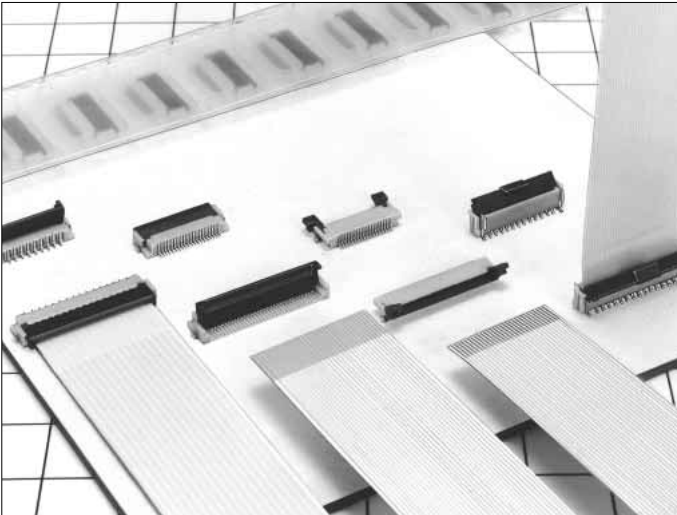

### ■ Features

#### 1. Ease of Use and Space Savings

Only one finger or 6.9N (Newtons) of force is required to lock Hirose's rotational actuator (flip-lock) as compared to using 2 fingers and 39.2N to close a FFC/FPC connector from our competition.

The Flip-Lock design also allows customers to place 2 or more connectors side by side as there is no need to waste additional board space for a side latch.

#### 2. Strengthened Flip-lock Actuator

The standard Flip-Lock requires only 2.0mm height above the board. A strengthened lock lever is available which only requires an additional 0.4mm.

#### 3. Supports Thin FPC (0.18mm)

Hirose does not require double-sided FPC to have any additional strengthening plate or stiffener and can therefore support a thickness of as little as 0.18mm +/- 0.05.

#### 4. Hirose Ensures Reliability

Hirose's patented half tuning fork contacts maintain the required normal force without relying on the connector housing. With our competitor's conventional products the housing walls support the contact force, which does not provide for long-term reliability.

#### 5. Prevention of Solder Bridge

Excess solder cavity absorbs excessive solder and avoids solder bridging.

#### 6. Three different assembly types

FH12 is offered in Top & Bottom Contact and Vertical Mount and offered in both a 0.5mm contact pitch as well as a 1.0mm contact pitch (bottom contact only).

### ■ Applications

Notebook computers, printers, PDAs, digital cameras and other compact devices for interconnecting the main circuit board with the LCD, HDD or other device.

#### Rotating One-touch Mechanism

①

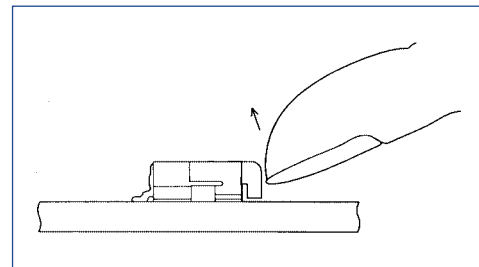

②

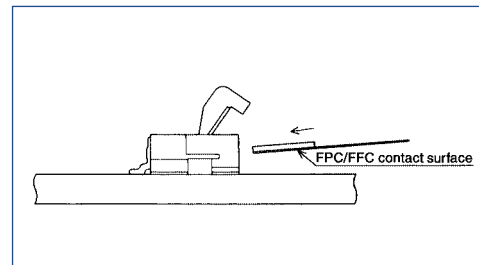

③

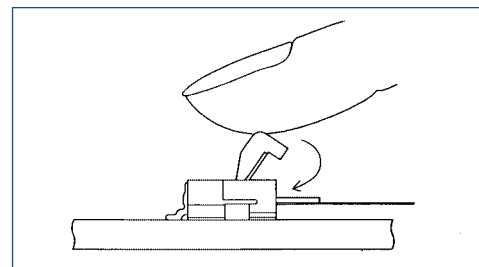

## Product Specifications

Rating	Current rating: 0.5A DC(Note 1)	Operating Temperature Range: -40 to +70°C (Note 2)	Storage Temperature Range: -10 to +50°C (Note 3)
	Voltage rating: 50V AC	Operating Humidity Range: Relative humidity, 90% max. (Not dewed)	Storage Humidity Range: Relative humidity, 90% max. (Not dewed)

Applicable FPC	t=0.3±0.05 Gold plated	t=0.18 ± 0.05 for FH12F-*S-0.5SH
----------------	------------------------	----------------------------------

Item	Specification	Conditions
1. Insulation resistance	500M ohms minimum	100V DC
2. Withstanding voltage	No flashover or insulation breakdown.	150V AC/1 minute
3. Contact resistance	50m ohms maximum	1mA
4. Durability (Insertion/withdrawal)	Contact resistance: 50m ohms maximum No damage, cracks, or parts dislocation.	20 cycles
5. Vibration	No electrical discontinuity of 1μs or more Contact resistance: 50m ohms maximum. No damage, cracks, or parts dislocation.	Frequency: 10 to 55 Hz, single amplitude of 0.75 mm, 2 hours in each of the 3 directions.
6. Shock	No electrical discontinuity of 1μs or more Contact resistance: 50m ohms maximum. No damage, cracks, or parts dislocation.	Acceleration of 490 m/s <sup>2</sup> , 11 ms duration, sine half-wave waveform, 3 cycles in each of the 3 axis.
7. Humidity(Steady state)	Contact resistance: 50m ohms maximum. Insulation resistance: 50M ohms minimum. No damage, cracks, or parts dislocation.	96 hours at 40°C and humidity of 90% to 95%
8. Temperature Cycle	Contact resistance: 50m ohms maximum. Insulation resistance: 50M ohms minimum. No damage, cracks, or parts dislocation.	Temperature: -40°C → 15 to 35°C → 85°C → 15 to 35°C, Time: 30 → 5 max. → 30 → 5 max.(minutes) 5 cycles
9. Resistance to Soldering heat	No deformation of components affecting performance.	Reflow: At the recommended temperature profile Manual soldering: 350±5°C for 3 seconds

Note 1: When passing the current through all of the contacts, use 70% of the current rating.

Note 2: Includes temperature rise caused by current flow.

Note 3: The term "storage" refers to products stored for long period of time prior to mounting and use. Operating Temperature Range and Humidity range covers nonconducting condition of installed connectors in storage, shipment or during transportation.

## Material

Part	Material	Finish	Remarks
Insulator	Polyamide, LCP(60 pos.)	Color : Beige	UL94V-0
Actuator	PPS	Color : Dark brown	
Contact	Phosphor bronze	Gold plated	
Metal Fittings	Brass	Tin plated	

## Ordering Information

**FH12**    **A** - **10** (**4**) - **S** **A** - **0.5** **SH** (**55**)  
 ①            ②            ③            ④            ⑤            ⑥            ⑦            ⑧            ⑨

① Series Name : FH12	⑤ Contact alignment: Single
② Blank : standard type A : Top contact type S : Type with strengthened flip-lock actuator F : Type with 0.18mm FPC End Thickness	⑥ Eccentric direction: Blank : standard type A : Eccentric type
③ Standard type : Number of contacts Eccentric type : Number of contacts in 0.5mm housing	⑦ Contacts Pitch : 0.5mm, 1mm
④ Standard type : Blank Eccentric type : Number of contacts	⑧ Contact type SH : SMT horizontal mounting type SV : SMT vertical mounting type
	⑨ Plating specification (55) : Gold plated



**FH12 Series 0.5mm and 1mm Pitch Connectors For FPC/FPC**

**Series Configuration**

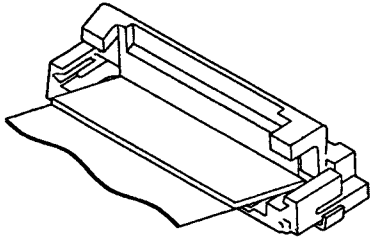
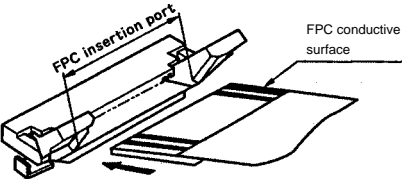
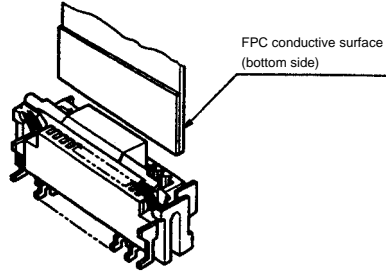
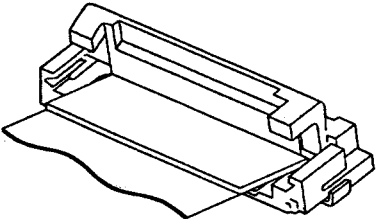
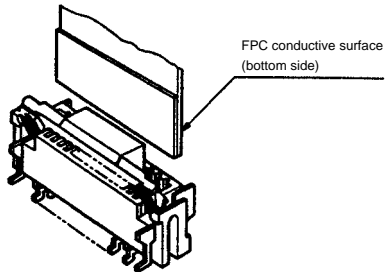
Pitch	Bottom Contact Type	Top Contact Type	Vertical mounting Type
0.5mm	 <p><b>FH12- ** S-0.5SH</b> <b>P.12</b>                      Number of contacts 6, 8, 10, 11, 12, 13, 14, 15, 16, 17, 18, 19, 20, 22, 24, 25, 26, 28, 30, 32, 33, 34, 35, 36, 40, 45, 50, 53</p>		
	<p>Type with Strengthened Lock Lever</p>		
	<p><b>FH12S- ** S-0.5SH</b> <b>P.13</b>                      Number of contacts 30, 40, 45, 50, 53</p>		
	<p>Type with 0.18mm FPC End Thickness</p>		
	<p><b>FH12F- ** S-0.5SH</b> <b>P.14</b>                      Number of contacts 6, 8, 10, 12, 13, 14, 15, 16, 18, 20, 22, 24, 25, 26, 28, 30, 32, 34, 36, 40</p>		
1mm	 <p>Standard <b>FH12- ** S-1SH</b> <b>P.18</b>                      Eccentric <b>FH12- ** (***) SA-1SH</b>                      Standard                      Number of contacts 5, 6, 7, 8, 9, 11, 12, 16, 17, 22, 26                      Eccentric                      Number of contacts 4, 6, 8, 10, 11, 14, 19, 24</p>		 <p><b>FH12- ** S-1SV</b> <b>P.19</b>                      Number of contacts 6, 7, 8, 16, 20, 22, 24</p>

## 0.5mm Pitch Bottom Contact Type

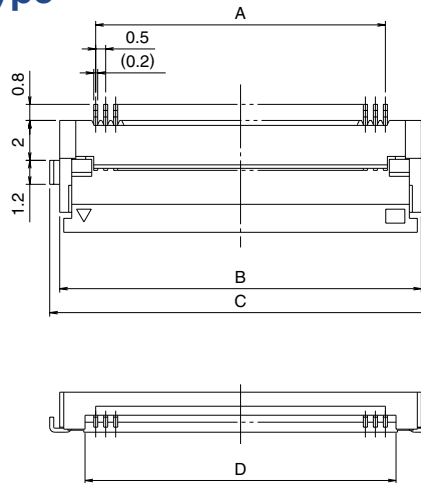

Mated Cross-sectional Diagram

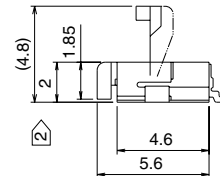
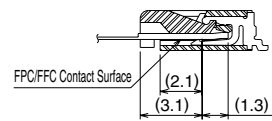

Unit:mm

Part Number	CL No.	Number of Contacts	A	B	C	D	RoHS
FH12- 6S-0.5SH(55)	586-0582-5-55	6	2.5	6.1	7.1	3.57	YES
FH12- 8S-0.5SH(55)	586-0744-5-55	8	3.5	7.1	8.1	4.57	
FH12-10S-0.5SH(55)	586-0522-3-55	10	4.5	8.1	9.1	5.57	
FH12-11S-0.5SH(55)	586-0600-5-55	11	5	8.6	9.6	6.07	
FH12-12S-0.5SH(55)	586-0704-0-55	12	5.5	9.1	10.1	6.57	
FH12-13S-0.5SH(55)	586-0549-0-55	13	6	9.6	10.6	7.07	
FH12-14S-0.5SH(55)	586-0533-0-55	14	6.5	10.1	11.1	7.57	
FH12-15S-0.5SH(55)	586-0523-6-55	15	7	10.6	11.6	8.07	
FH12-16S-0.5SH(55)	586-0531-4-55	16	7.5	11.1	12.1	8.57	
FH12-17S-0.5SH(55)	586-0606-1-55	17	8	11.6	12.6	9.07	
FH12-18S-0.5SH(55)	586-0530-1-55	18	8.5	12.1	13.1	9.57	
FH12-19S-0.5SH(55)	586-0534-2-55	19	9	12.6	13.6	10.07	
FH12-20S-0.5SH(55)	586-0524-9-55	20	9.5	13.1	14.1	10.57	
FH12-22S-0.5SH(55)	586-0532-7-55	22	10.5	14.1	15.1	11.57	
FH12-24S-0.5SH(55)	586-0521-0-55	24	11.5	15.1	16.1	12.57	
FH12-25S-0.5SH(55)	586-0692-3-55	25	12	15.6	16.6	13.07	
FH12-26S-0.5SH(55)	586-0576-2-55	26	12.5	16.1	17.1	13.57	
FH12-28S-0.5SH(55)	586-0612-4-55	28	13.5	17.1	18.1	14.57	
Note ② FH12-30S-0.5SH(55)	586-0525-1-55	30	14.5	18.1	19.1	15.57	
FH12-32S-0.5SH(55)	586-0681-7-55	32	15.5	19.1	20.1	16.57	
FH12-33S-0.5SH(55)	586-0520-8-55	33	16	19.6	20.6	17.07	
FH12-34S-0.5SH(55)	586-0617-8-55	34	16.5	20.1	21.1	17.57	
FH12-35S-0.5SH(55)	586-0740-4-55	35	17.0	20.6	21.6	18.07	
FH12-36S-0.5SH(55)	586-0526-4-55	36	17.5	21.1	22.1	18.57	
Note ② FH12-40S-0.5SH(55)	586-0527-7-55	40	19.5	23.1	24.1	20.57	
Note ② FH12-45S-0.5SH(55)	586-0528-0-55	45	22	25.6	26.6	23.07	
Note ② FH12-50S-0.5SH(55)	586-0529-2-55	50	24.5	28.1	29.1	25.57	
Note ② FH12-53S-0.5SH(55)	586-0595-7-55	53	26	29.6	30.6	27.07	

Note 1 : Embossed tape reel packaging (2,000 pieces/reel).  
 Order by number of reels.

Note ② : If there is no problem with the connector height, we recommend the type with the strengthened Flip-lock actuator (FH12S-\*S-0.5SH).  
 Standard type connector height: 2 mm  
 Connector height of type with strengthened Flip-lock actuator: 2.4 mm





## Cameras Applications



Automotive Driver Pilot



Live Streaming



Video Conference



Eye Tracker Biometric Detection



Machine Vision



Agricultural Monitor

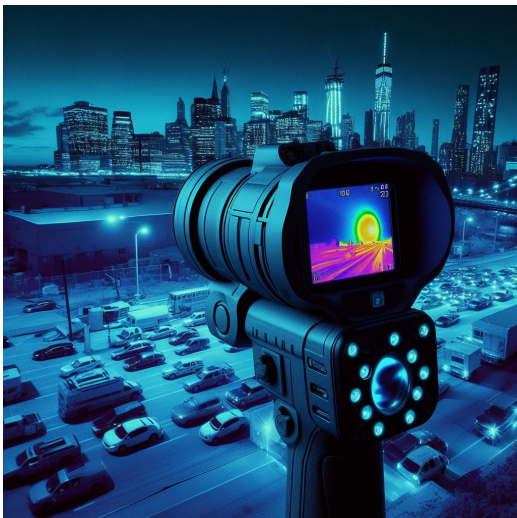

Night Vision Security



Drone and Sports Eagle Eyes



Interactive Pet Camera





your **BEST** camera module partner

## Cameras Applications





## Camera Module Pinout Definition Reference Chart

OmniVision	Sony	Samsung	On-Semi	Aptina	Himax	GalaxyCore	PixArt	SmartSens	Sensors
Pin Signal									
Description									
DGND	GND								
AGND									
PCLK	DCK								
XCLR	PWDN	XSHUTDOWN	STANDBY						
MCLK	XVCLK	XCLK	INCK						
RESET	RST								
NC	NULL								
SDA	SIO_D	SIOD							
SCL	SIO_C	SIOC							
VSYNC	XVS	FSYNC							
HREF	XHS								
DOVDD									
AFVDD									
AVDD									
DVDD									
STROBE	FSTROBE								
FSIN									
SID									
ILPWM									
FREX									
GPIO									
SLASEL									
AFEN									
<b>MIPI Interface</b>									
MDN0	DN0	MD0N	DATA_N	DMO1N					
MDP0	DP0	MD0P	DATA_P	DMO1P					
MDN1	DN1	MD1N	DATA2_N	DMO2N					
MDP1	DP1	MD1P	DATA2_P	DMO2P					
MDN2	DN2	MD2N	DATA3_N	DMO3N					
MDP2	DP2	MD2P	DATA3_P	DMO3P					
MDN3	DN3	MD3N	DATA4_N	DMO4N					
MDP3	DP3	MD3P	DATA4_P	DMO4P					
MCN	CLKN	CLK_N	DCKN						
MCP	CLKP	MCP	CLK_P	DCKN					
<b>DVP Parallel Interface</b>									
D0	DO0	Y0							
D1	DO1	Y1							
D2	DO2	Y2							
D3	DO3	Y3							
D4	DO4	Y4							
D5	DO5	Y5							
D6	DO6	Y6							
D7	DO7	Y7							
D8	DO8	Y8							
D9	DO9	Y9							
D10	DO10	Y10							
D11	DO11	Y11							



## Camera Reliability Test

Reliability Inspection Item		Testing Method	Acceptance Criteria	
Category	Item			
Environmental	Storage Temperature	High 60°C 96 Hours	Temperature Chamber	No Abnormal Situation
		Low -20°C 96 Hours	Temperature Chamber	No Abnormal Situation
	Operation Temperature	High 60°C 24 Hours	Temperature Chamber	No Abnormal Situation
		Low -20°C 24 Hours	Temperature Chamber	No Abnormal Situation
	Humidity	60°C 80% 24 Hours	Temperature Chamber	No Abnormal Situation
	Thermal Shock	High 60°C 0.5 Hours Low -20°C 0.5 Hours Cycling in 24 Hours	Temperature Chamber	No Abnormal Situation
Physical	Drop Test (Free Falling)	Without Package 60cm	10 Times on Wood Floor	Electrically Functional
		With Package 60cm	10 Times on Wood Floor	Electrically Functional
	Vibration Test	50Hz X-Axis 2mm 30min	Vibration Table	Electrically Functional
		50Hz Y-Axis 2mm 30min	Vibration Table	Electrically Functional
		50Hz Z-Axis 2mm 30min	Vibration Table	Electrically Functional
	Cable Tensile Strength Test	Loading Weight 4 kg 60 Seconds Cycling in 24 Hours	Tensile Testing Machine	Electrically Functional
Electrical	ESD Test	Contact Discharge 2 KV	ESD Testing Machine	Electrically Functional
		Air Discharge 4 KV	ESD Testing Machine	Electrically Functional
	Aging Test	On/Off 30 Seconds Cycling in 24 Hours	Power Switch	Electrically Functional
	USB Connector	On/Off 250 Times	Plug and Unplug	Electrically Functional







Inspection Item		Inspection Method	Standard of Inspection		
Category	Item				
Appearance	FPC/ PCB	Color	The Naked Eye	Major Difference is Not Allowed.	
		Be Torn/Chopped	The Naked Eye	Copper Crack Exposure is Not Allowed.	
		Marking	The Naked Eye	Clear, Recognizable (Within 30cm Distance)	
	Holder	Scratches	The Naked Eye	The Inside Crack Exposure is Not Allowed	
		Gap	The Naked Eye	Meet the Height Standard	
		Screw	The Naked Eye	Make Sure Screws Are Presented (If Any)	
		Damage	The Naked Eye	The Inside Crack Exposure is Not Allowed	
	Lens	Scratch	The Naked Eye	No Effect On Resolution Standard	
		Contamination	The Naked Eye	No Effect On Resolution Standard	
		Oil Film	The Naked Eye	No Effect On Resolution Standard	
		Cover Tape	The Naked Eye	No Issue On Appearance.	
	Function	Image	No Communication	Test Board	Not Allowed
			Bright Pixel	Black Board	Not Allowed In the Image Center
Dark Pixel			White board	Not Allowed In the Image Center	
Blurry			The Naked Eye	Not Allowed	
No Image			The Naked Eye	Not Allowed	
Vertical Line			The Naked Eye	Not Allowed	
Horizontal Line			The Naked Eye	Not Allowed	
Light Leakage			The Naked Eye	Not Allowed	
Blinking Image			The Naked Eye	Not Allowed	
Bruise			Inspection Jig	Not Allowed	
Resolution			Chart	Follows Outgoing Inspection Chart Standard	
Color			The Naked Eye	No Issue	
Noise			The Naked Eye	Not Allowed	
Corner Dark			The Naked Eye	Less Than 100px By 100px	
Color Resolution			The Naked Eye	No Issue	
Dimension	Height	The Naked Eye	Follows Approval Data Sheet		
	Width	The Naked Eye	Follows Approval Data Sheet		
	Length	The Naked Eye	Follows Approval Data Sheet		
	Overall	The Naked Eye	Follows Approval Data Sheet		



## KLT Package Solutions

KLT Camera Module

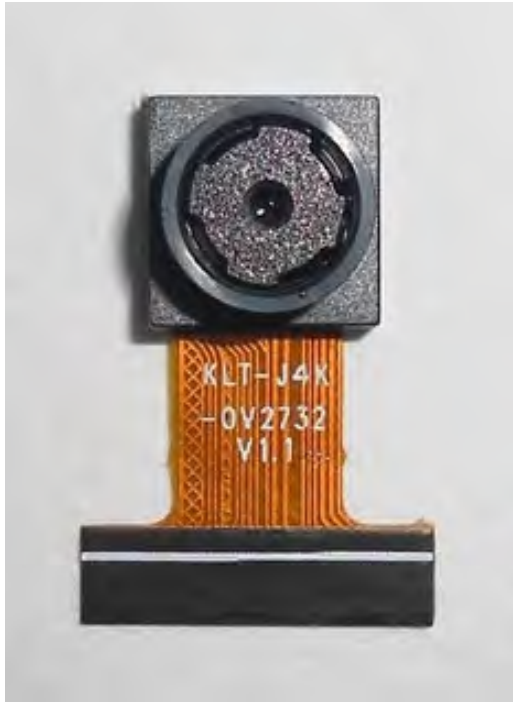

Complete with Lens Protection Film



Tray with Grid and Space



Place Cameras on the Tray







## Camera Modules Package Solution

Full Tray of Cameras

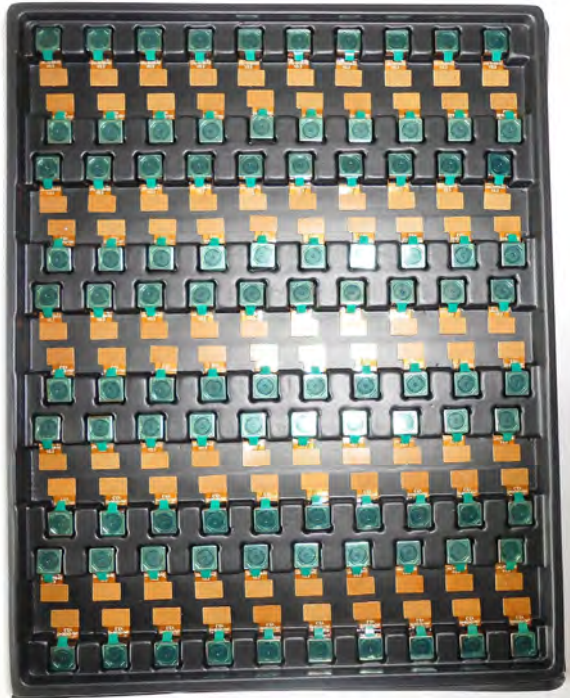

Cover Tray with Lid



Put Tray into Anti-Static Bag



Vacuum the Anti-Static Bag

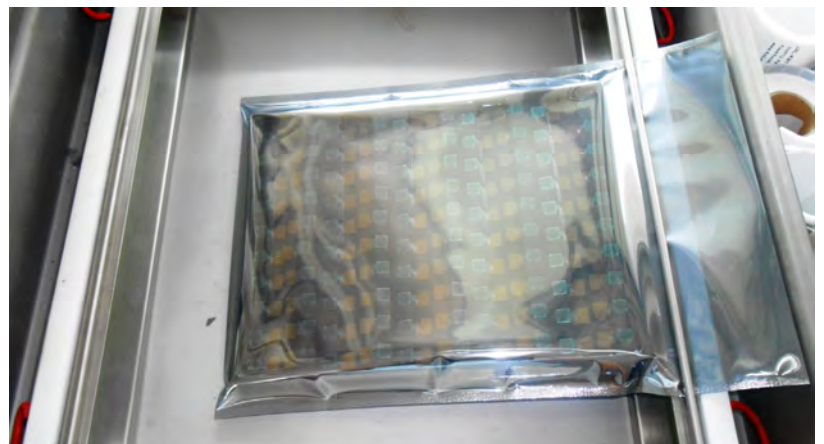



## Camera Modules Package Solution

Sealed Vacuum Bag with Labels

1. Model and Description 2. Quantity 3. Shipping Date 4. Caution







## Large Order Package Solution

Place Foam Sheets Between Trays



Foam Sheets are Slightly Larger than Trays



Place Foam Sheets and Trays into Box



Foam Sheets are Tightly Fitting Box





## Small Order Package Solution

Place Foam Sheets and Trays into Small Box



Foam Sheets are Nicely Fitting the Small Box



Package in Small Box for Shipment



Place Small Boxes into Larger Box







*your BEST camera module partner*

## Carbon Box Package Solution

Seal the Carbon Box

Final Package Labelled Box



### Carbon Box Ready for Shipment

1. Delivery Address and Phone No. 2. Box No. and Ship Date 3. Fragile Caution





## Sample Order Package Solution

Place Sample into Small Anti-Static Bag



Place Connectors into Small Ant-Static Bag



### Sample Labels on the Small Bag

1. Camera Module or Connector Model
2. Shipping Date and Quantity
3. Caution







## Connectors Large Order Package Solution

Connectors in a Wheel



Label Connectors in the Wheel



The Wheel is Perfectly Fitting the Box



Connectors Box Ready for Shipment





*your BEST camera module partner*

## Company Kai Lap Technologies (KLT)

Kai Lap Technologies Group Limited. (KLT) was established in 2009, a next-generation technology driven manufacturer specialized in research, design, and produce of audio and video products. KLT is occupying 20,000 square feet automated plants with 100 employees of annual throughput 30,000,000 units cameras.

KLT provides OEM, ODM design, contract manufacturing, and builds the camera products. You may provide the requirements to us, even with a hand draft, our sales and engineering work together to meet your needs. We consider ourselves your last-term partner in developing practical and innovative solutions.

Our team covers everything from initial concept development to mass produced product. KLT specializes in customized camera design, raw material, electronic engineering, firmware/software development, product testing, and packing design. Our experienced strategic supply systems offer a robust and dependable manufacturing capacity for orders of various sizes.

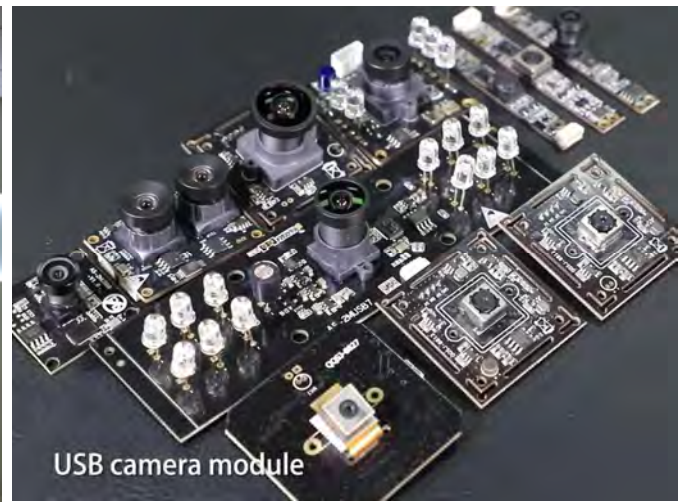

## Limited Warranty

KLT provides the following limited warranty if you purchased the Product(s) directly from KLT company or from KLT's website, [www.KaiLapTech.com](http://www.KaiLapTech.com). Product(s) purchased from other sellers or sources are not covered by this Limited Warranty. KLT guarantees that the Product(s) will be free from defects in materials and workmanship under normal use for a period of one (1) year from the date you receive the product ("Warranty Period").

For all Product(s) that contain or develop material defects in materials or workmanship during the Warranty Period, KLT will, at its sole option, either: (i) repair the Product(s); (ii) replace the Product(s) with a new or refurbished Product(s) (replacement Product(s) being of identical model or functional equivalent); or (iii) provide you a refund of the price you paid for the Product(s).

This Limited Warranty of KLT is solely limited to repair and/or replacement on the terms set forth above. KLT is not reliable or responsible for any subsequent events.







# CMOS CAMERA MODULES



*your BEST camera module partner*

## KLT Strength

### Powerful Factory



### Professional Service



### Promised Delivery



[www.KaiLapTech.com](http://www.KaiLapTech.com) [sales@KaiLapTech.com](mailto:sales@KaiLapTech.com) Tel: (852) 6908 1256 Fax: (852) 3017 6778

All rights reserved @ Kai Lap Technologies Group Ltd. Specifications subject to change without notice.